

SimBox H128mm

Modul Box Assembly Instruction

Special Features:

- Length: 270, 300, 350, 400, 450, 500, 550mm.
- The drawer side-board is 128mm high.
- Drawer width can be designed freely with automatic error adjustment.
- Hidden full pullout silencing sliding skid can bear 30kg and enjoys
- excellent stability and quite and smooth sliding performance.
- Quick installation and dismantle.
- Newly-designed built-in damper is free from reinstallation and ensures soft and smooth drawer movements.

Basic length	Internally usable drawer depth	Minimum installation depth of drawer	Minimum installation height
270mm	244mm	270mm	161mm
300mm	274mm	300mm	161mm
350mm	324mm	350mm	161mm
400mm	374mm	400mm	161mm
450mm	424mm	450mm	161mm
500mm	474mm	500mm	161mm
550mm	524mm	550mm	161mm

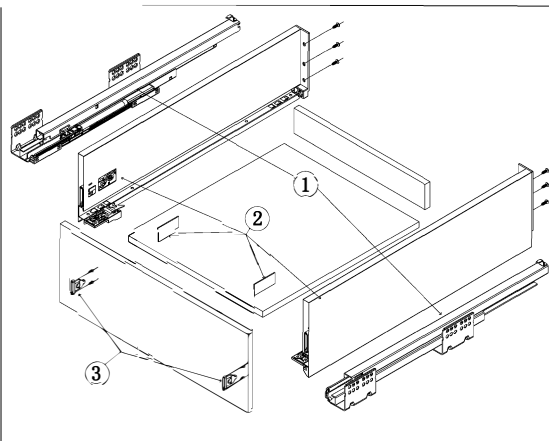
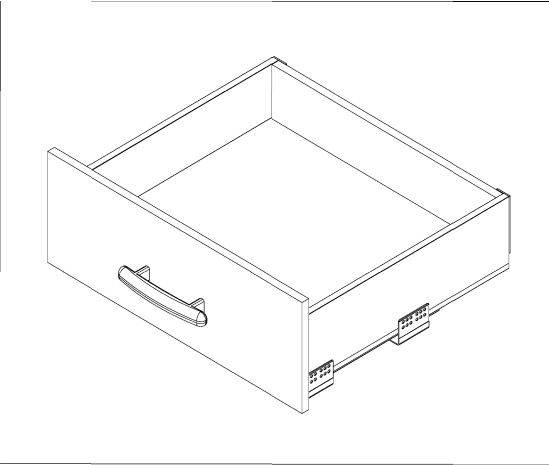

1. Guide Left/Right Length: 270mm, 300mm, 350mm, 400mm, 450mm, 500mm, 550mm

2. Drawer Side & Decorative Cap Left/Right Length: 270mm, 300mm, 350mm, 400mm, 450mm, 500mm, 550mm

3. Front connector Left / Right

Technology pivot: Bottom and Back Panel Measurement 16MM Density Panel

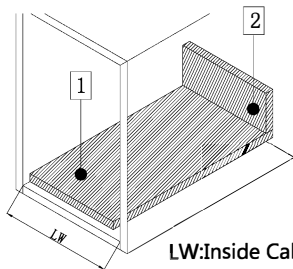

- 1** Bottom panel width=Inside Cabinet Width-19±0.5
Bottom panel length=Runner length-20MM
- 2** Back panel height= 101MM
Back panel width=Inside Cabinet Width-42±0.5

Runner Installation(mm)

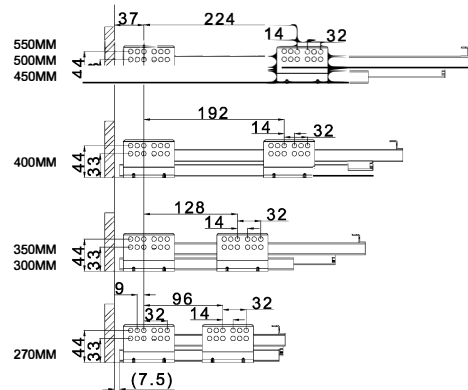

Basic length: 270/300/350/400/450/500/550

Inside Cabinet Dimension

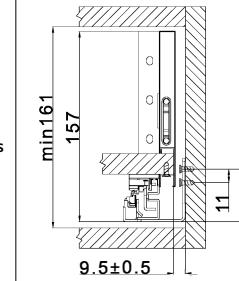

Front Panel Mounting Positions

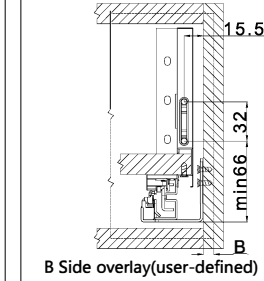

Front Fixing Brackets Positions

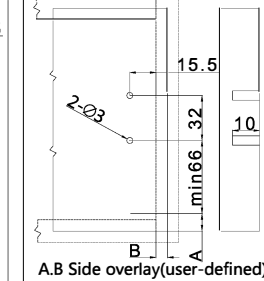

Back Panel Mounting Positions

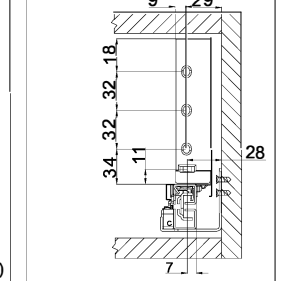

Front fixing brackets mounting

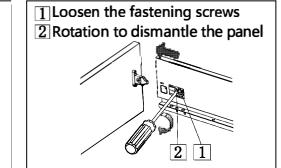
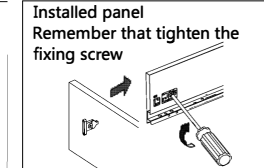
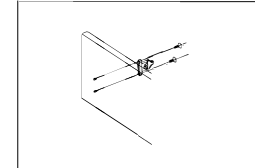

Front panel height adjustment : ±2mm

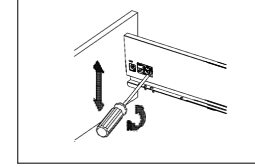

Front panel side adjustment : right 1mm

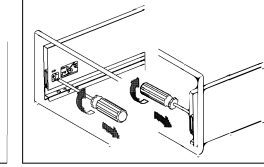

Front panel side adjustment : left 1mm

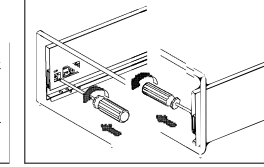

Mounting the drawer

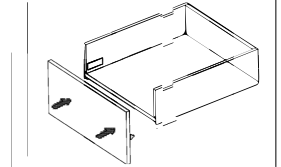
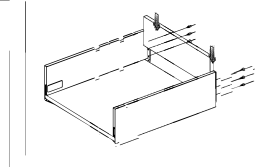
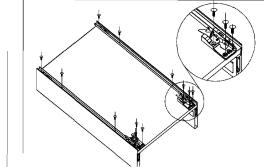
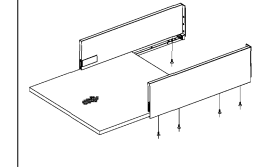

Installing the drawer

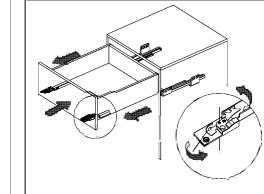
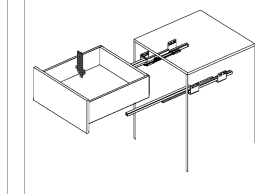
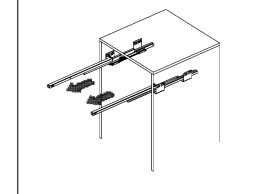

Removing the drawer

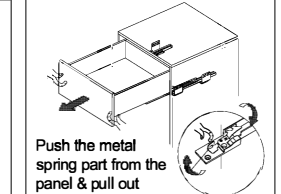

Function of the damper

